

Stopping and positioning modules for automation technology

Product overview – 2023

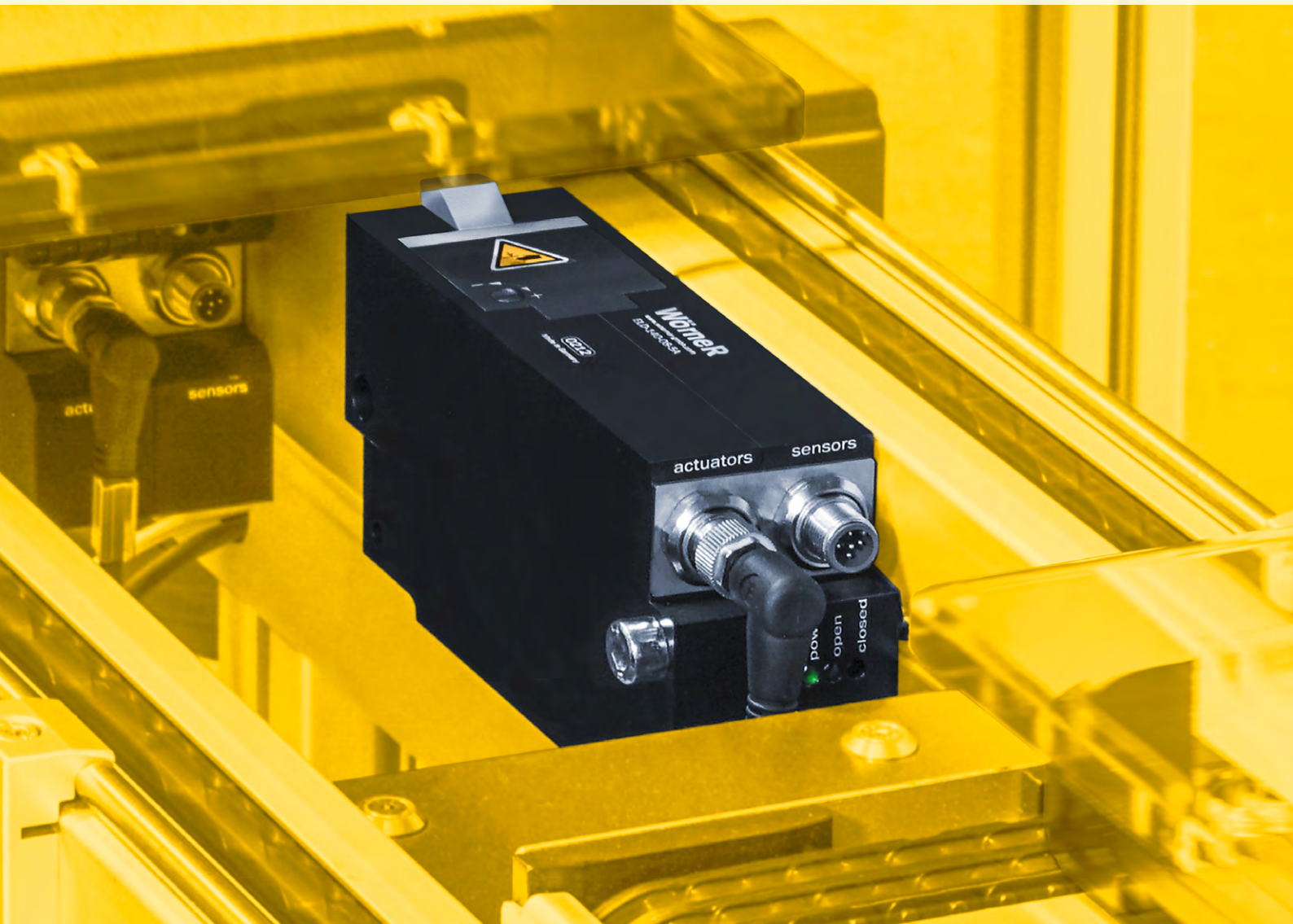

Der Würner-Stopper. Das Original.

Electric stoppers for every requirement



Extensive product family: Electric stoppers with highest efficiency

Electrically driven stoppers provide numerous advantages:

- more than 70 % higher efficiency (compared to pneumatic systems)
- low operating costs
- minimal installation expenditure
- integrated sensors
- simple control of material flow
- low noise

Wörner electric stoppers are engineered to meet the requirements of a vast range of industries, with a proven track record in countless industrial automation applications.

Transport speed, pallet weight and robustness parameters determine the selection of the suitable Wörner component.

EL You will find the stoppers of the proven ELD line starting on page 18.

Electric stoppers in a new variety



ELD-40



ELD-140



ELD-660



ELD-70



ELD-195



ELD-430



Damping, stopping, positioning: The right solution for every requirement



... to an international specialist for leading-edge stoppers

Wörner's product portfolio covers more than 2.500 components: stoppers, angle dampers, index cylinders and anti-bounce stops are successfully applied in all conventional assembly and conveyor systems in a large variety of industrial sectors.

Experience grown over decades, excellent industry know-how and a modern, highly specialized machine park guarantee that even unusual customer demands can be satisfied.

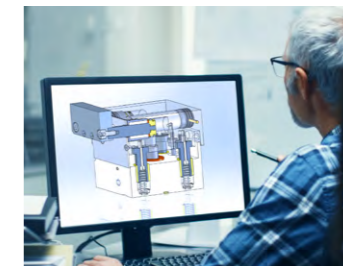

From a simple workshop ...

The success story of our stoppers is based on the brilliant idea of the creative mind Helmut Wörner. The technology was patented in Germany 1990, from there the triumph takes its course: Within Europe and soon also internationally.

Today, Wörner stoppers are well-known around the globe. They are in fact a synonym for precision, durability and a safe investment.

The first industrial stopper, the Wörner Delta „SDEH-5000“ (1986)



New, custom solutions through close collaboration

We welcome the chance to put our skills to the test with special tasks: The Wörner expert team generates solutions for any requirement – either from the existing product range of standard products or by designing a tailor-made solution in close cooperation with the customer.



Uncompromising quality and performance

Wörner products “Made in Germany” ...

Wörner has always been committed to an effective quality management system.

The entire Wörner staff is dedicated to achieve our most important goals: providing top performance for the highest quality of all products and services, achieving greatest customer satisfaction and ensuring competitiveness.

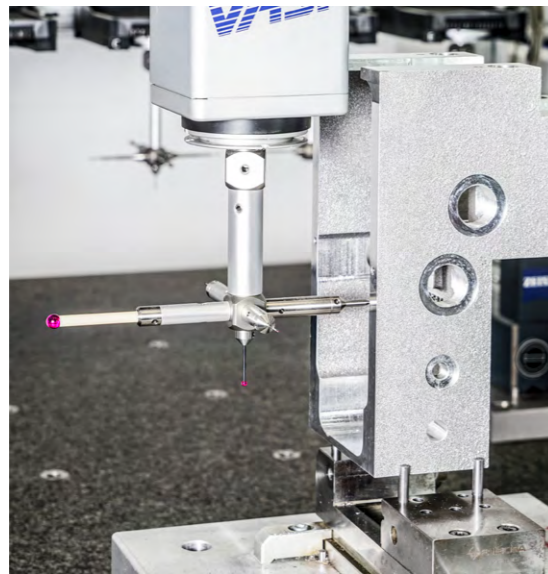

Component coordinate-measuring

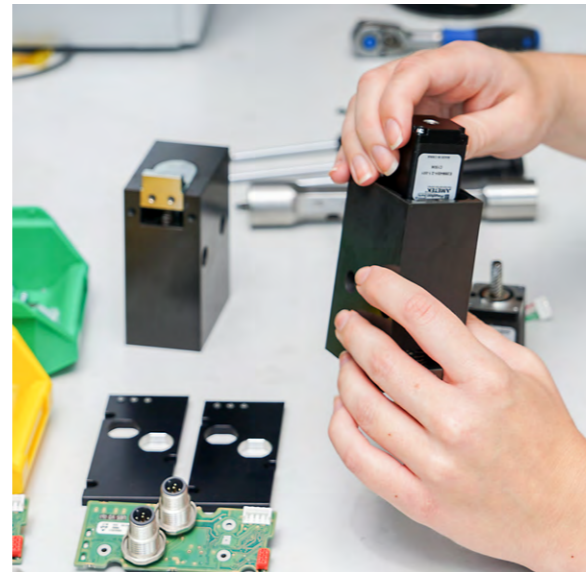

Electrical stopper assembly

... successfully applied all over the world

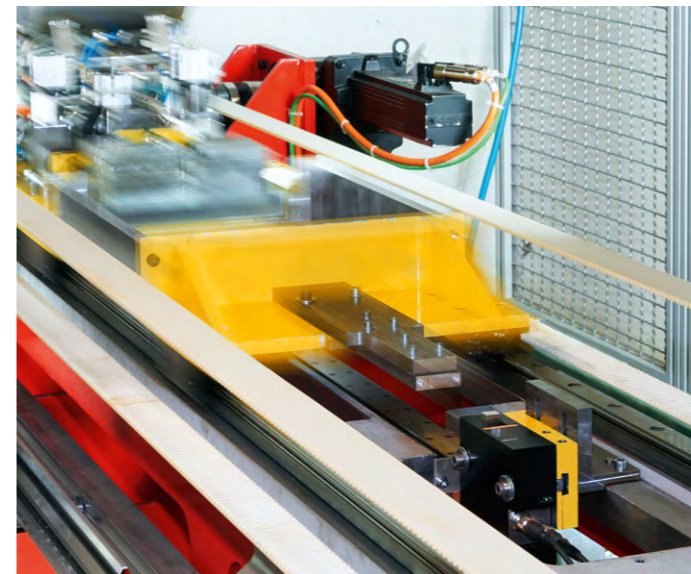

Endurance testing

Wörner's quality and environmental management systems are successfully certified in accordance to the international standards DIN ISO 9001 and ISO 14001. When developing new products, they have to pass extensive endurance tests.



Packaging and shipping

After assembly, every single unit goes through a final inspection.

Before any component leaves the factory, it is carefully packed. Through the international distribution network, Wörner products and services are available world wide.

Wörner components for automated assembly, handling and manufacturing

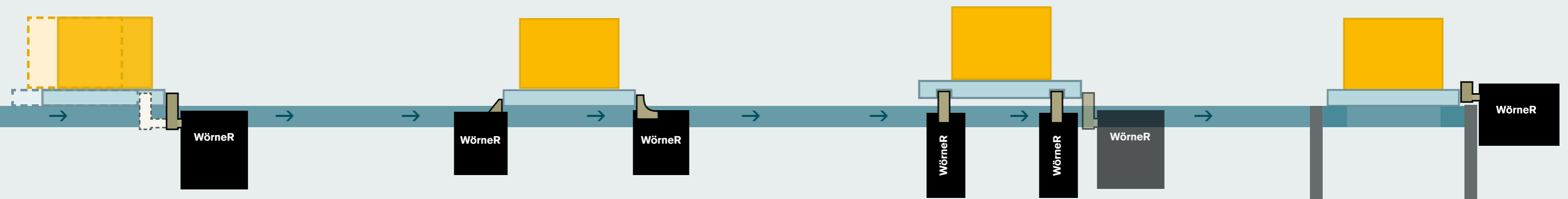

Damped stoppers

For shock-sensitive, fragile parts. Pallets are gently decelerated as they arrive so that workpieces reach their final position without rebound.

Anti-bounce stops

Anti-bounce stops hold the pallet loaded with individual parts in position with absolute precision to prevent any rebound.

Undamped stoppers

The tough, economical basic design. Suitable for use wherever one or more pallets are to be accumulated at a defined position.

Index cylinders

These guarantee precise vertical lifting of pallets and are ideal for rapid positioning tasks. The workpiece can be processed without vibration.

Angle dampers

Angle dampers are the preferred solution for changes of direction during the conveying of shock-sensitive or fragile parts.

Workpiece
 Pallet (for workpiece)
 Conveyor system (e.g. belt, chain, roller conveyor)

Product overview



The easy way to find the right product:

First of all, choose the **product family** and **product group**.

Then look for the corresponding **basic product** in the relevant table.

You can find the right **product variant** for your system using the data sheet associated with each basic product.

Please also refer to the technical explanations on pages 32/33.

The name of the product variant also serves as its order code (see notes on page 34).

If you need help identifying the variant you need, just get in touch with our service hotline:

Phone: +49 711 601 609 0
E-mail: sales@woerner-gmbh.com

You can always find the latest information on our portfolio at www.woerner-gmbh.com/en/
Our website now also has a convenient search function to help you find the right product. Please feel free to try it out!

A Wörner core competence:

Custom solutions based on customer requirements

In addition to our proven standard products, we offer a variety of custom-built special solutions. You will find examples of these on the following pages under “**Custom-built ...**”.

Just contact us if your project involves special requirements and requires a specific solution!

Product family

Stoppers

Stopping and clearing

Product group

Page

Pneumatic undamped stoppers

D0 / PNU 10

Pneumatic damped stoppers

DBS / PND 13

Electric undamped stoppers

DEL0 / ELU 18

Electric damped stoppers

DEL / ELD 19

Pneumatic damped stoppers for roller systems

DBSR 22

Accelleration Units

DAU 24

Displacement Stops

DDU / DDS 25

Angle dampers

Stopping with change of direction

Pneumatic /electric angle dampers

DBSQ / ELDQ 26

Index cylinders

Raising and positioning

Pneumatic index cylinders

DI / DIA 28

Anti-bounce stops

Preventing rebound

Pneumatic /electric anti-bounce stops

DR / DRP / DRE 29
PNR / PNRP
DR-R

Accessories

Adapting products and extending their functionality

30

Pneumatic undamped stoppers

Image	Basic product							Variants	Image	Basic product							
	Lowering stroke	Damping stroke	max. propelling force	Scope of application*		at	Weight			Lowering stroke	Damping stroke	max. propelling force	Scope of application*		at	Weight	
	D0-70	7 mm	n/a	48 N	06 m/min 09 12 18 24 30 36	70 kg 50 25 12 7 4 3		EW/DW H/K I/E cust.-spec. solutions var. access.		PNU-395	9 mm	n/a	275 N	06 m/min 09 12 18 24 30 36	400 kg 300 250 200 110 65 50		EW U cust.-spec. solutions var. access.
	D0-120	9 mm	n/a	82 N	06 m/min 09 12 18 24 30 36	120 kg 100 100 100 50 30 20		EW/DW H/K I/E cust.-spec. solutions var. access.		D0-400	9 mm 15 mm 25 mm 40 mm	n/a	275 N	06 m/min 09 12 18 24 30 36	400 kg 300 250 200 110 65 50		EW/DW H/H2/K E G/V/KE cust.-spec. solutions var. access.
	D0-140	8 mm	n/a	96 N	06 m/min 09 12 18 24 30 36	140 kg 120 100 100 50 30 25		EW/DW H/K I cust.-spec. solutions var. access.		D0-400-R	9 mm	n/a	275 N	06 m/min 09 12 18 24 30 36	400 kg 300 250 200 110 65 50		EW/DW rustproof cust.-spec. solutions var. access.
	D0-200	13 mm	n/a	206 N**	06 m/min 09 12 18 24	200 kg** 150** 120** 100** 60**		EW/DW H/K E W50/W90 cust.-spec. solutions var. access.		D0-810	10 mm 20 mm	n/a	549 N	06 m/min 09 12 18 24 30 36	810 kg 810 810 810 450 250 250		EW/DW H/K I/E G cust.-spec. solutions var. access.
	D0-300	50 mm	n/a	206 N	06 m/min 09 12 18 24 30 36	300 kg 225 125 60 35 20 15		DW H/K cust.-spec. solutions var. access.									

EW single-acting
DW double-acting
H/H2 heat-resistant
K cold-resistant

I prepared for inductive position sensor
E prepared for electronic position sensor





G/KE stop plate with thread /Elastomer stop plate
V extended stop plate
W50 tilted stop plate 50°
W90 tilted stop plate 90°

* All specifications given for a coefficient of friction of $\mu = 0.07$
** Scope of application depends on operating mode (EW/DW) and stop plate design (W50/W90), see data sheet

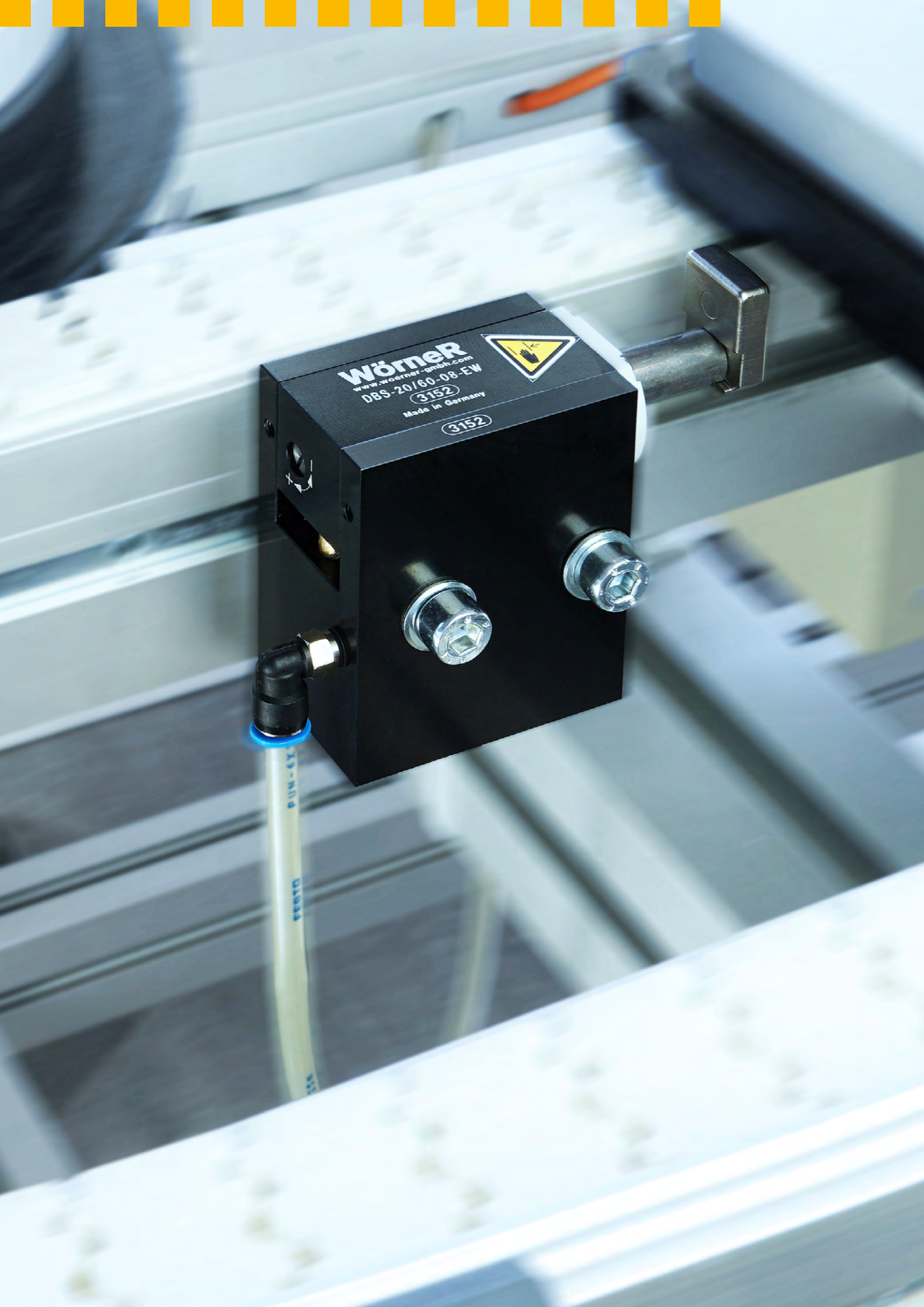
Note: The scope of application for undamped stoppers is highly dependent on the conditions of use, in particular on the coefficient of friction between the conveyor equipment and pallet and on the rigidity of the conveyor. We can provide you with detailed technical advice when making your choice - just ask us!

Pneumatic damped stoppers



	<u>Basic product</u>	Lowering stroke	Damping stroke	min./max. propelling force	Scope of application*		<u>Variants</u>
					at	Weight	
	DBS-18	7 mm	10 mm	0.5 N 15 N	06 m/min 09 12 18 24 30 36	22 kg 20 13 7 4 3 2	EW/DW H/K I/E KU cust.-spec. solutions var. access.
	PND-67	8 mm	24 mm	2.5 N 100 N	06 m/min 09 12 18 24 30 36	65 kg 44 38 33 26 19 11	KI
	DBS-90	8 mm 13 mm	30 mm	2.5 N 100 N	06 m/min 09 12 18 24 30 36	90 kg 70 60 50 40 30 22	EW/DW RD H/K E/I KI/KU/KA/V S
	DBS-140	8 mm	30 mm	2.5 N 160 N	06 m/min 09 12 18 24 30 36	150 kg 140 100 80 50 40 30	EW/DW H/K E cust.-spec. solutions var. access.

EW single-acting
DW double-acting
RD reduced damping stroke
H/H2 heat-resistant
K cold-resistant

I prepared for inductive position sensor
E prepared for electronic position sensor
KI tilt stop
KU plastic stop

KA plastic stop antistatic
V extended stop plate
S prepared for stop position sensing

* All specifications given for a coefficient of friction of $\mu = 0.07$

Pneumatic damped stoppers

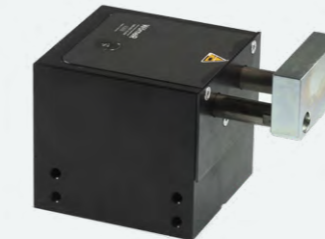
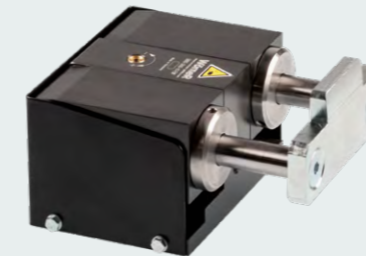
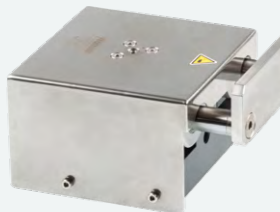

Basic product	Lowering stroke	Damping stroke	min./max. propelling force	Scope of application*		Variants	Image	Basic product	Lowering stroke	Damping stroke	min./max. propelling force	Scope of application*		Variants
				at	Weight							at	Weight	
DBS-150	15 mm	20 mm	3.5 N 103 N	06 m/min 09 12 18 24 30 36	170 kg 140 100 80 50 40 25	EW/DW H/K KI cust.-spec. solutions var. access.		DBS-255	9 mm	38 mm	3.5 N 300 N	06 m/min 09 12 18 24 30	270 kg 220 160 110 60 40	EW/DW H/K E S19/S35 cust.-spec. solutions var. access.
DBS-150-T4	11.5 mm	20 mm	3.5 N 103 N	06 m/min 09 12 18 24 30 36	150 kg 100 100 90 55 35 25	EW/DW H/K cust.-spec. solutions var. access.		DBS-300	11 mm	24 mm	8.3 N 206 N	06 m/min 09 12 18 24 30	300 kg 270 250 225 140 95	EW/DW H/K I S cust.-spec. solutions var. access.
DBS-170	8 mm	27.5 mm	4 N 200 N	06 m/min 09 12 18 24 30 36	200 kg 160 145 90 55 40 30	EW/DW H/H2/K E KI/S19/S50 cust.-spec. solutions var. access.		DBS-900	15 mm	45.7 mm	6 N 700 N	06 m/min 09 12 18 24 30 36	900 kg** 800** 730** 410** 250** 180** 90**	EW/DW RD H/K KI/KU S cust.-spec. solutions var. access.
DBS-240	9 mm	24 mm	8 N 165 N	06 m/min 09 12 18 24 30	240 kg 220 200 180 110 70	EW/DW H/K KI/S20/S50/ S100 cust.-spec. solutions var. access.		DBS-1150	15 mm	21 mm	30 N 700 N	09 m/min 12 18 24 30	700 kg** 750** 850** 550** 350**	EW/DW KI/KU S cust.-spec. solutions var. access.
DBS-240-R	9 mm	24 mm	30 N 165 N	06 m/min 09 12 18 24 30	240 kg 220 200 180 110 70	EW/DW K rustproof cust.-spec. solutions var. access.		DBS-2000	15 mm	25.4 mm	130 N 700 N	06 m/min 09 12 18 24 30	2000 kg** 1800** 1400** 1000** 600** 400**	EW/DW H/K KI/KU S cust.-spec. solutions var. access.

EW single-acting
 DW double-acting
 RD reduced damping stroke
 H/H2 heat-resistant
 K cold-resistant

I prepared for inductive position sensor
 E prepared for electronic position sensor

KI tilt stop
 KU plastic stop
 S prepared for stop position sensing

S19 steel stop, 19 mm wide
 S20 steel stop, 20 mm wide
 S21 steel stop, 21 mm wide

S35 steel stop, 35 mm wide
 S50 steel stop, 50 mm wide
 S100 steel stop, 100 mm wide

* All specifications given for a coefficient of friction of $\mu = 0.07$
 ** Exceptionally, these values apply at a coefficient of friction of $\mu = 0.02$

Pneumatic damped stoppers

Image	Basic product	Lowering stroke	Damping stroke	min./max. propelling force		Scope of application*	Variants	Image	Basic product	Lowering stroke	Damping stroke	min./max. propelling force		Scope of application*	Variants	
				at	Weight							at	Weight			
	DBS-3000	15 mm	46 mm	145 N	1800 N	09 m/min 12 18 24	3000 kg** 2600 ** 2500 ** 2000 **	EW/DW MD S cust.-spec. solutions var. access.		DBSST-35	7 mm	15.2 mm	1 N 29 N	06 m/min 09 12 18 24 30 36	42 kg 28 24 18 17 12 7	EW/DW H/K cust.-spec. solutions var. access.
	DBSS06-10	8 mm	6 mm	0.5 N 7 N		06 m/min 09 12 18 24 30	10 kg 5 5 4 5 1.5	EW/DW H/K KI/KU/KA I cust.-spec. solutions var. access.		DBSST-130	7 mm	18.3 mm	2 N 90 N	06 m/min 09 12 18 24 30 36	130 kg 90 77 60 40 38 20	EW/DW H/K cust.-spec. solutions var. access.
	DBSS10-20	8 mm	10 mm	0.5 N 14 N		06 m/min 09 12 18 24 30	20 kg 10 8 6 3.5 2.5	EW/DW H/K KI/KU/KA, I clean room ISO cl. 5 cust.-spec. var. access.		DBSU-150	9 mm	22 mm	3.5 N 103 N	06 m/min 09 12 18 24 30 36	150 kg 100 100 90 55 35 25	EW/DW H/K KI cust.-spec. solutions var. access.
	DBSSI-20	8 mm	14 mm	1 N 14 N		06 m/min 09 12 18 24 30 36	20 kg 15 12 10 6 4 2.5	EW/DW H/K I cust.-spec. solutions var. access.		DBSU-270	9 mm	25.5 mm	7 N 185 N	06 m/min 09 12 18 24 30 36	270 kg 220 200 180 110 70 50	EW/DW H/K E KI cust.-spec. solutions var. access.

Custom-built:

DBS-1100-15-EW-011



With integrated anti-bounce stop designed to keep the pallet in position after the damping operation. A sealed cover that travels simultaneously with the damping unit protects the device against dirt and aggressive liquids. The solution also includes a retracted stop sensor (damping completed but mechanism still locked) and makes it possible to lock the stop in the lower position. Ideally suited for use in harsh environments, e.g. when linking machining centers in the automotive industry.

EW single-acting
DW double-acting
H heat-resistant
K cold-resistant





I prepared for inductive position sensor
KI tilt stop
KU plastic stop
KA plastic stop antistatic

S prepared for stop position sensing
E prepared for electronic position sensor

* All specifications given for a coefficient of friction of $\mu = 0.07$
** Exceptionally, these values apply at a coefficient of friction of $\mu = 0.02$

Electric undamped stoppers / Rotary Switch

Electric damped stoppers

Image	Basic product					Variants	Image	Basic product					Variants	
	Lowering stroke	Damping stroke	min./max. propelling force	Scope of application*				Lowering stroke	Damping stroke	min./max. propelling force	Scope of application*			
				at	Weight									
	DELO-65	9 mm	n/a	– 65 N	06 m/min 65 kg 09 60 12 55 18 50	2x5-pin M12x1 plug KU R cust.-spec. solutions var. access.			ELD-40	7.5 mm	10 mm	0.4 N 45 N	06 m/min 40 kg 09 30 12 20 18 11 24 10 30 8 36 5	2x5-pin M12x1 plug KU cust.-spec. solutions var. access.
	DELO-120	14 mm	n/a	– 206 N	06 m/min 300 kg 09 140 12 80 18 35 24 20 30 13 36 9	2x5-pin M12x1 plug R cust.-spec. solutions var. access.			ELD-70	8 mm	13 mm	1.4 N 90 N	06 m/min 70 kg 09 45 12 40 18 29 24 15 30 10 36 7	2x5-pin M12x1 plug F KU cust.-spec. solutions var. access.
	ELU-20	7 mm	n/a	1 N 20 N	06 m/min 20 kg 09 12 12 7 18 3	1x4-pin M12x1 plug KI cust.-spec. solutions var. access.			ELD-140	8 mm	15 mm	1.5 N 90 N	06 m/min 140 kg 09 120 12 75 18 45 24 28 30 17 36 12	2x5-pin M12x1 plug S KI/KU cust.-spec. solutions var. access.
	ELU-30	7 mm	n/a	1.2 N 35 N	06 m/min 30 kg 09 15 12 9 18 4	1x4-pin M12x1 plug KI cust.-spec. solutions var. access.			ELD-195	8 mm	20 mm	2.5 N 200 N	06 m/min 195 kg 09 170 12 150 18 80 24 50 30 35 36 25	2x5-pin M12x1 plug F KU cust.-spec. solutions var. access.
	DELW Rotary Switch	n/a	n/a	n/a	n/a	2x5-pin M12x1 plug cust.-spec. solutions var. access.			ELD-430	11 mm	25 mm	3.5 N 420 N	06 m/min 430 kg 09 340 12 280 18 180 24 120 30 90 36 50	2x5-pin M12x1 plug KU/KI cust.-spec. solutions var. access.

KI tilt stop R with spring reset
 KU plastic stop F fast
 S steel stop

* All specifications given for a coefficient of friction of $\mu = 0.07$

Electric damped stoppers

Image	Basic product	Lowering stroke	Damping stroke	min./max. propelling force	Scope of application*		Variants	Image	Basic product	Lowering stroke	Damping stroke	min./max. propelling force	Scope of application*		Variants
					at	Weight							at	Weight	
	ELD-660	11 mm	20 mm	5 N 450 N	06 m/min 09 12 18 24 30 36	660 kg 600 450 250 130 90 60	2x5-pin M12x1 plug S KI/KU cust.-spec. solutions var. access.		DEL-650	9.3 mm	16.1 mm	30 N 419 N	06 m/min 09 12 18 24 30	650 kg** 630** 470** 350** 250** 200**	RC cust.-spec. solutions var. access.
	ELD-1200	20 mm	25 mm	65 N 750 N	06 m/min 09 12 18	1350 kg** 1350** 1200** 700**	3x5-pin M12x1 plug, cust.-spec. solutions var. access.		DEL-800	9.3 mm	20.2 mm	50 N 419 N	06 m/min 09 12 18 24 30	820 kg** 790** 760** 640** 520** 340**	RC cust.-spec. solutions var. access.
	DEL-235	9.3 mm	16.1 mm	25 N 419 N	06 m/min 09 12 18 24 30	250 kg** 190** 180** 135** 110** 55**	RC cust.-spec. solutions var. access.		DEL-1100	9.3 mm	20.2 mm	65 N 419 N	06 m/min 09 12 18 24	1100 kg** 1000** 850** 750** 500**	RC cust.-spec. solutions var. access.
	DEL-400	9.3 mm	16.1 mm	25 N 419 N	06 m/min 09 12 18 24 30	400 kg** 340** 330** 255** 190** 150**	RC cust.-spec. solutions var. access.		DEL-1800	9.3 mm	20.2 mm	100 N 419 N	06 m/min 09 12 16 18	1800 kg** 1700** 1550** 1000** 800**	RC cust.-spec. solutions var. access.
	DEL-630	8 mm	16 mm	32 N 250 N	06 m/min 09 12 18 24 30	650 kg** 610** 450** 300** 190** 140**	cust.-spec. solutions var. access.		DEL-350-S2	8 mm	25 mm	80 N 200 N	06 m/min 09 12	400 kg 350 250	HS cust.-spec. solutions var. access.

KI tilt stop
KU plastic stop
S steel stop

RC manual remote control
HS high speed

* All specifications given for a coefficient of friction of $\mu = 0.07$

** Exceptionally, these values apply at a coefficient of friction of $\mu = 0.02$

Pneumatic damped stoppers for roller systems

Image	Basic product		Lowering stroke	Damping stroke	min./max. propelling force	Scope of application*	Variants	Image	Basic product		Lowering stroke	Damping stroke	min./max. propelling force	Scope of application*	Variants
	DBSR-30	DBSR-1000							DBSR-270	ELUR-65					
	8 mm	5.8 mm	3.5 N 21 N	06 m/min 09 12 18	30 kg 25 12 8	EW/DW cust.-spec. solutions var. access.		15 mm	21 mm	41.3 N 618 N	09 m/min 12 18 24 30	900 kg 750 550 250 180	EW/DW cust.-spec. solutions var. access.		
	15 mm	17 mm	10.3 N 185 N	06 m/min 09 12 18 24 30 36	270 kg 230 150 60 30 25 20	EW/DW S cust.-spec. solutions var. access.		10 mm	n/a	– 65 N	06 m/min 09 12 18	65 kg 60 55 50	2x5-pin M12x1 plug, R cust.-spec. solutions var. access.		
	15 mm 25 mm	22 mm	10.3 N 275 N	06 m/min 09 12 18 24 30 36	400 kg 360 280 130 90 60 40	EW/DW cust.-spec. solutions var. access.									
	15 mm 25 mm**	28 mm	10.3 N 850 N	06 m/min 09 12 18 24 30	550 kg 470 350 190 120 85	EW cust.-spec. solutions var. access.									
	15 mm	36.7 mm	10 N 850 N	06 m/min 09 12 18 24 30	700 kg 580 470 230 145 108	EW/DW cust.-spec. solutions var. access.									

EW single-acting
 DW double-acting
 S prepared for stop
 position sensing
 R spring return

* All specifications given for a
 coefficient of friction of $\mu = 0.07$
 ** Version with slightly restricted
 damping capacity

Custom-built:

DBSR-400-15-EW-004

The unit possesses an integrated anti-bounce stop designed to keep the pallet in position after the damping operation. It is also pre-assembled with pre-adjusted clamping holders designed for the installation of inductive sensors to determine the stop positions.

Acceleration Units

Displacement Stops

Image	Basic product	Lowering stroke	Acceleration stroke	Acceleration force	Variants	Image	Basic product	Lowering stroke	Damping stroke	min./max. propelling force	Scope of application*		Variants
											at	Weight	
	DAU-80	8 mm	21.3 mm	228 N	EW/DW cust.-spec. solutions var. access.		DDS-80	17 mm	6.5 mm	6 N 54 N	06 m/min 09 12 18 24 30 36	80 kg 70 50 40 27 17 12	DW FS cust.-spec. solutions var. access.
	DAU-350	9 mm	38.8 mm	570 N	EW/DW cust.-spec. solutions var. access.		DDS-160	17 mm	12 mm	6 N 109 N	06 m/min 09 12 18 24 30 36	160 kg 140 100 90 55 35 25	DW FS cust.-spec. solutions var. access.
							DDU-100	17 mm	n/a	n/a 500 N	06 m/min 09 12 18 24 30 36	100 kg 90 70 60 50 28 12	DW FS cust.-spec. solutions var. access.

EW single-acting
DW double-acting

FS finger safety

* All specifications given for a coefficient of friction of $\mu = 0.07$

The acceleration unit ensures that the pallet leaves the stopping position more quickly so that the next cycle can start earlier. As soon as the stopper has lowered, the contact plate of the acceleration unit moves out and accelerates the pallet. (→)

This procedure can lead to a reduction of cycle times by more than 1 second or by more than 40 %.

Acceleration units have a continuously adjustable extension speed and thus cover a wide range of applications.

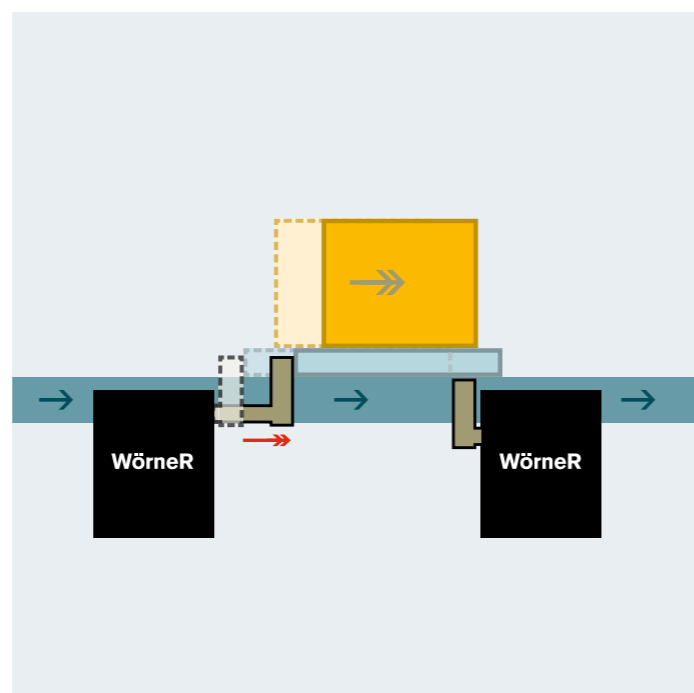

Displacement stops are integrated at a transverse section that connects more than two longitudinal sections. They take over transport control at line crossings and stop pallets e.g. on lifting transverse units. Thus the pallets can be transferred from a transverse to a longitudinal section. The displacement stop can perform different functions:

Function F1 "Stop pallet": This function is used when the pallet is to be transferred from a transverse section to the longitudinal section.

Function F2 "Continue pallet": This function is used if the pallet is to continue the cross transport at the line intersection.

■ Workpiece ■ Pallet (for workpiece)
■ Conveyor system (e.g. belt, chain, roller conveyor)

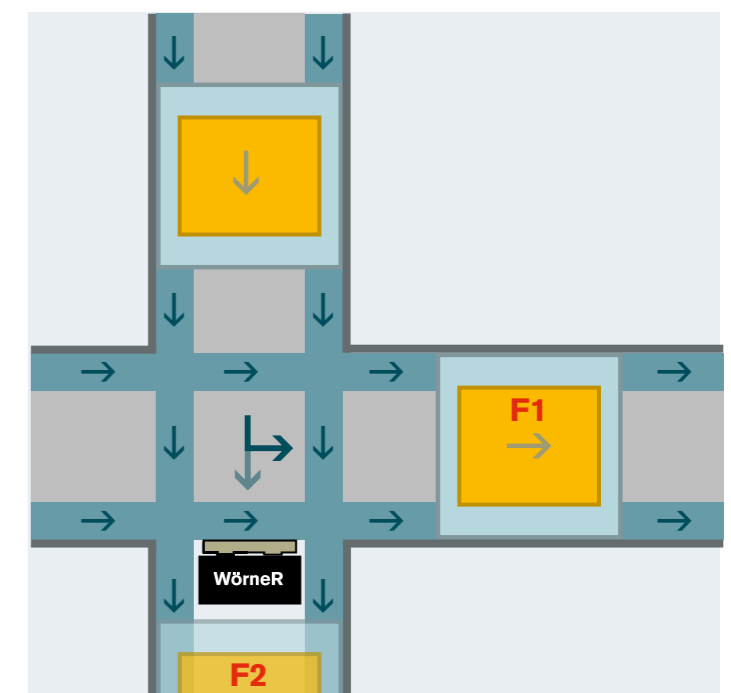

Pneumatic /electric angle dampers

Image	DBSQ-15						Image	DBSQ-270					
	Basic product	Damping stroke	min. propelling force	Scope of application*		Weight		Basic product	Damping stroke	min. propelling force	Scope of application*		Weight
	DBSQ-15	7 mm	0.2 N	at	Weight	H/K W/G cust.-spec. solutions var. access.		DBSQ-270	24 mm	6.9 N	at	Weight	H/K cust.-spec. solutions var. access.
				06 m/min	15 kg						06 m/min	270 kg	
				09	10						09	220	
				12	9						12	200	
				18	7						18	180	
				24	6						24	110	
				30	4						30	70	
				36	3						36	50	
	DBSQ-20/60	21.5 mm	0.7 N	06 m/min	60 kg	H/K W/KU/KA cust.-spec. solutions var. access.		DBSQ-300	24 mm	6.9 N	06 m/min	300 kg	H/K cust.-spec. solutions var. access.
				09	40						09	270	
				12	35						12	250	
				18	30						18	225	
				24	24						24	140	
				30	18						30	95	
				36	10						36	70	
	DBSQ-65	23 mm	0.7 N	06 m/min	65 kg	W cust.-spec. solutions var. access.		DBSQ-400	23 mm	4.8 N	06 m/min	400 kg	H/K cust.-spec. solutions var. access.
				09	43						09	280	
				12	37						12	240	
				18	32						18	140	
				24	25						24	100	
				30	19						30	60	
				36	11						36	40	
	DBSQ-150-T4	24 mm	3.4 N	06 m/min	150 kg	H/K cust.-spec. solutions var. access.		DBSQ-1100	21 mm	27.5 N	09 m/min	1100 kg	H/K cust.-spec. solutions var. access.
				09	100						12	1000	
				12	100						18	800	
				18	90						24	450	
				24	55						30	280	
				30	35								
				36	25								
	DBSQ-170	29 mm	3.4 N	06 m/min	220 kg	H/K cust.-spec. solutions var. access.		ELDQ-300	14.7 mm	6.9 N	06 m/min	300 kg	W cust.-spec. solutions var. access.
				09	190						09	250	
				12	160						12	150	
				18	150						18	80	
				24	90						24	40	
				30	50						30	35	
				36	40						36	30	

H heat-resistant
 K cold-resistant
 KU plastic stop
 KA plastic stop
 antistatic
 W angle stop
 G straight stop

* All specifications given for a coefficient of friction of $\mu = 0.07$

Index cylinders

Anti-bounce stops

	<i>Basic product</i>	Stroke	Force	max. lateral force	<i>Variants</i>
	DIA-495	31.0 mm	495 N	170 N	H I/E U cust.-spec. solutions var. access.
	DI-1050	31.5 mm	1050 N	170 N	H I/E cust.-spec. solutions var. access.
	DIA-1050	31.5 mm	1050 N	170 N	H I/E cust.-spec. solutions var. access.
	DI-2200-25-001	25.0 mm	2200 N	240 N	Special variant



Custom-built:

DI-1050-15-007

This unit was designed as a round construction in contrast to our usual index cylinders. It is also equipped with an integrated cover.

	<i>Basic product</i>	Stroke	<i>Variants</i>	<i>Preferred application</i>
	DR	8 mm	cust.-spec. solutions var. access.	compact all-rounder with many accessories
	DRP	8 mm	I/E EA ST cust.-spec. solutions var. access.	compact all-rounder with many accessories
	DRE	9 mm	cust.-spec. solutions var. access.	all-rounder with electric lowering
	DR-R	8 mm	n/a	Suitable for dirty environments
	PNR	8 mm	n/a	low cost product, suitable for low pallet weights and propelling forces
	PNRP	8 mm	n/a	low cost product, suitable for low pallet weights and propelling forces

H heat-resistant
I prepared for inductive position sensor
E prepared for electronic position sensor

U universally, can be used for all types of conveyor profiles
EA electronic sensor at stop
ST Stopper

Accessories

Product-specific accessories

We offer an extensive range of accessories to accompany our products. For details, please refer to the relevant data sheets.

By way of example, the accessories illustrated here are for a pneumatically driven, damped stopper.

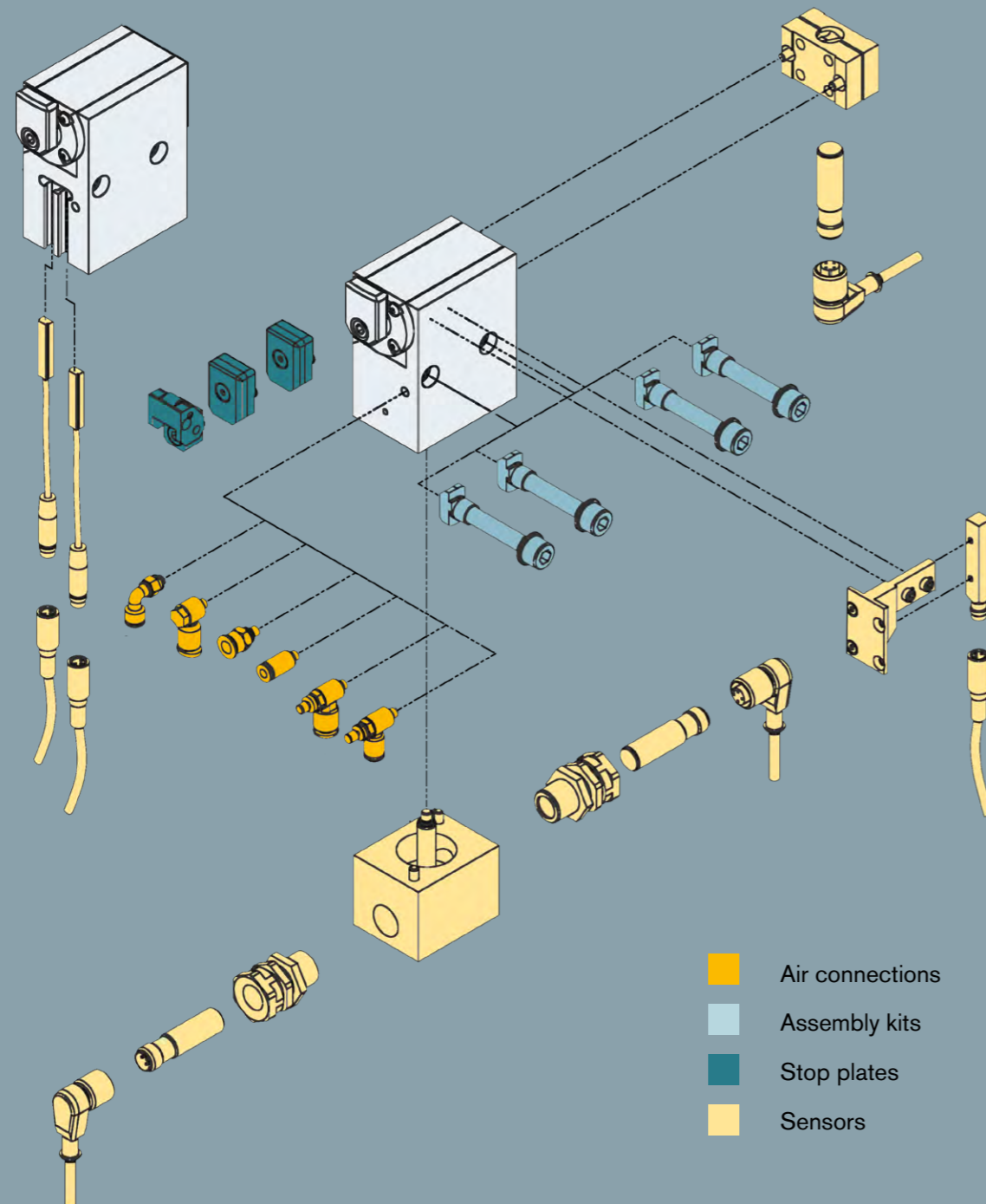

Product-independent accessories

Position sensor for pallet

Basic product

DP

Variants

AU / AS
cust.-spec.
solutions

Sensor bracket

DSA

H/K
cust.-spec.
solutions

H heat-resistant
K cold-resistant
AU bottom-mounted sensor
AS side-mounted sensor

Calculation aid

Maximum pallet weight as a function of friction coefficient and conveying speed

You want to know the max. pallet weight for a different conveying speed and/or a different coefficient of friction?

Then you can easily determine the max. pallet weight for your application using the calculation aid at

www.woerner-gmbh.com/support.

Or simply contact our service hotline directly at:

Telefon: +497116016090

E-Mail: sales@woerner-gmbh.com

Technical explanations

Basic function: Lowering

Propelling force F_R

The propelling force F_R is the friction force between the conveyor equipment and the pallet. It is a function of the coefficient of friction μ , the weight of the pallet m and acceleration due to gravity g :

$$F_R = \mu \cdot m \cdot g$$

If more than one pallet has been accumulated than the number of pallets n must also be considered:

$$F_R = n \cdot \mu \cdot m \cdot g$$

The coefficient of friction μ is a function of the friction between the conveyor equipment and the pallet.

Examples for the coefficient of friction:

Belt/band: $\mu = 0.2$ to 0.3
 Plastic modular belt: $\mu = 0.3$ to 0.5
 Accumulation roller chain: $\mu = 0.01$ to 0.03

Example calculation:

$m_{\text{workpiece}} = 5 \text{ kg}$
 $m_{\text{pallet}} = 2 \text{ kg}$
 $\mu = 0.2$
 $g = 9.81 \text{ m/s}^2$
 $F_R = (5 + 2) \text{ kg} \cdot 0.2 \cdot 9.81 \text{ m/s}^2 = 13.7 \text{ N}$

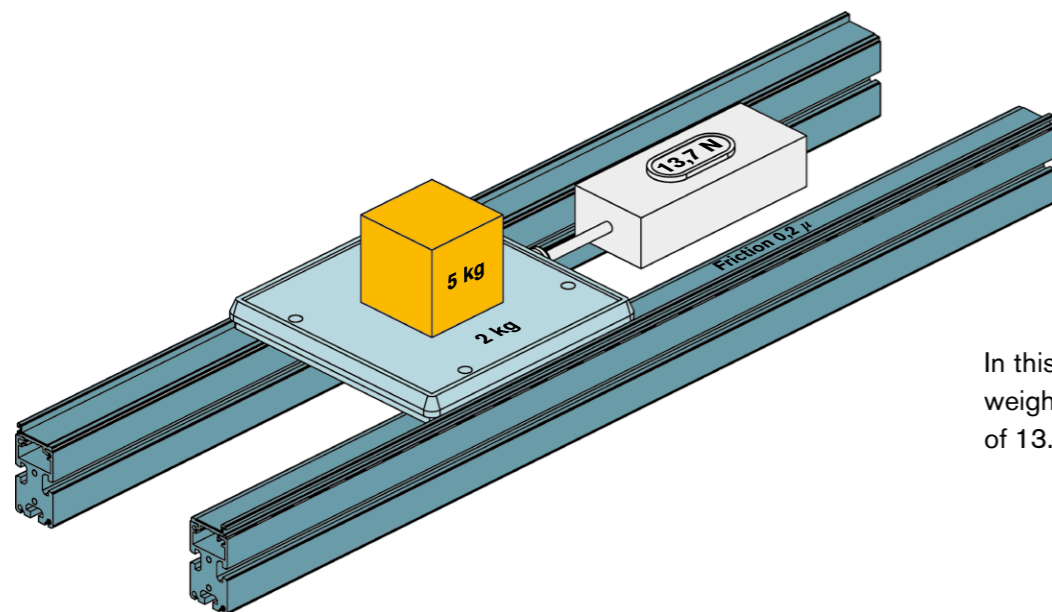

In this example, a pallet of total weight 7 kg exerts a propelling force of 13.7 N on a double belt conveyor.

The product brochure and data sheets indicate the maximum propelling force against which the stopper can reliably lower during long-term operation. The propelling force in your system must be less than the specified value.

Example for DBS-90:

(Value given for coefficient of friction $\mu = 0.07$):
 Maximum propelling force 100 N

Please note that other pallet weights can be reliably lowered at different coefficients of friction. Using the formula above, you can easily convert the maximum propelling force specified by us for other coefficients of friction.

We would be happy to advise you – just contact us!

Basic function: Stopping

Deceleration force F_v

(by way of example for damped stopper)

The deceleration force F_v is required to slow the pallet down to a halt and dissipate the kinetic energy stored in the pallet. It consists of the damping force (at conveyor speed v and damping stroke s) and the propelling force, which continues to have an effect even during the damping operation:

$$F_v = \frac{m \cdot v^2}{2s} + m \cdot g \cdot \mu$$

The scope of application of the various stoppers is indicated in the product brochure and data sheets. Using these tables, it is easy to determine whether the intended stopper is able to damp the expected pallet weight at your required conveyor speed.

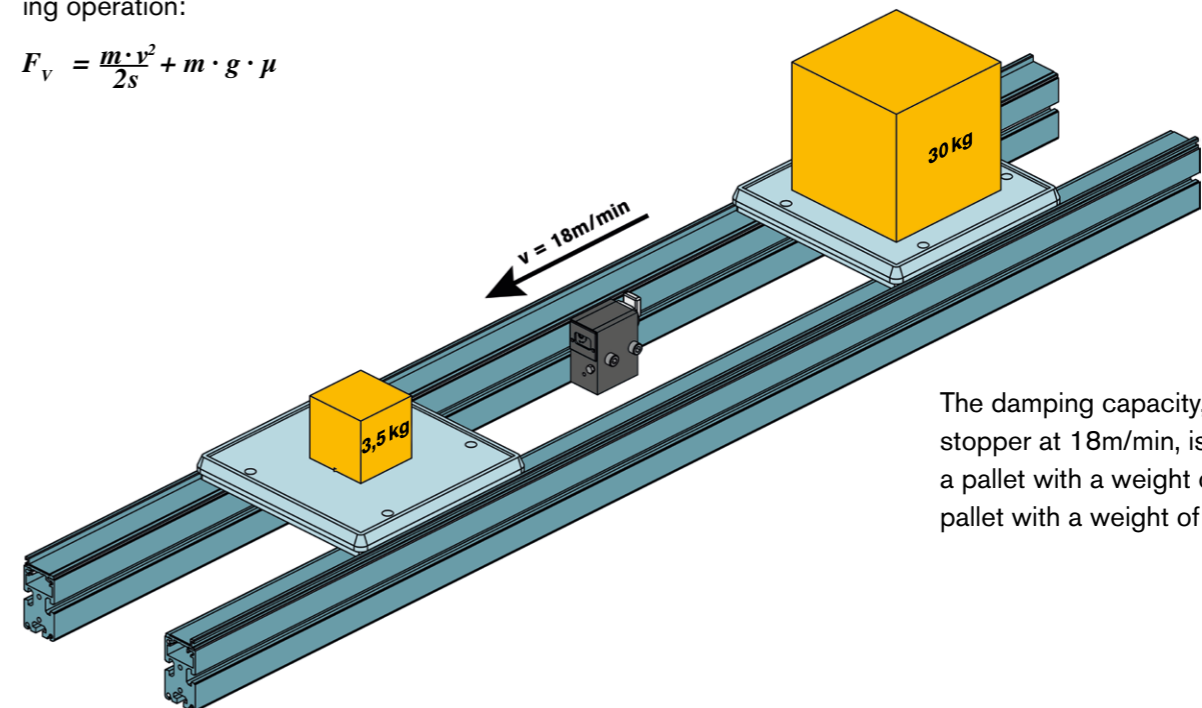

The damping capacity, e.g. of a DBS-90 stopper at 18m/min, is sufficient for both a pallet with a weight of 5 kg and for a pallet with a weight of 50 kg.

Example for DBS-90

(Values given for coefficient of friction $\mu = 0.07$):

Conveyor speed	Pallet weight
06 m/min	90 kg
09 m/min	70 kg
24 m/min	60 kg
12 m/min	50 kg
18 m/min	40 kg
30 m/min	30 kg
36 m/min	22 kg

Please note that other combinations of the conveyor speed and pallet weight parameters are possible, or may indeed be required, at different coefficients of friction. This is true, in particular, when the propelling force accounts for a high proportion of the deceleration force, i.e. in systems with high levels of friction.

You can obtain an initial approximation of these values using the formula above.

We would be happy to advise you – just contact us!

Overview of the Wörner product system

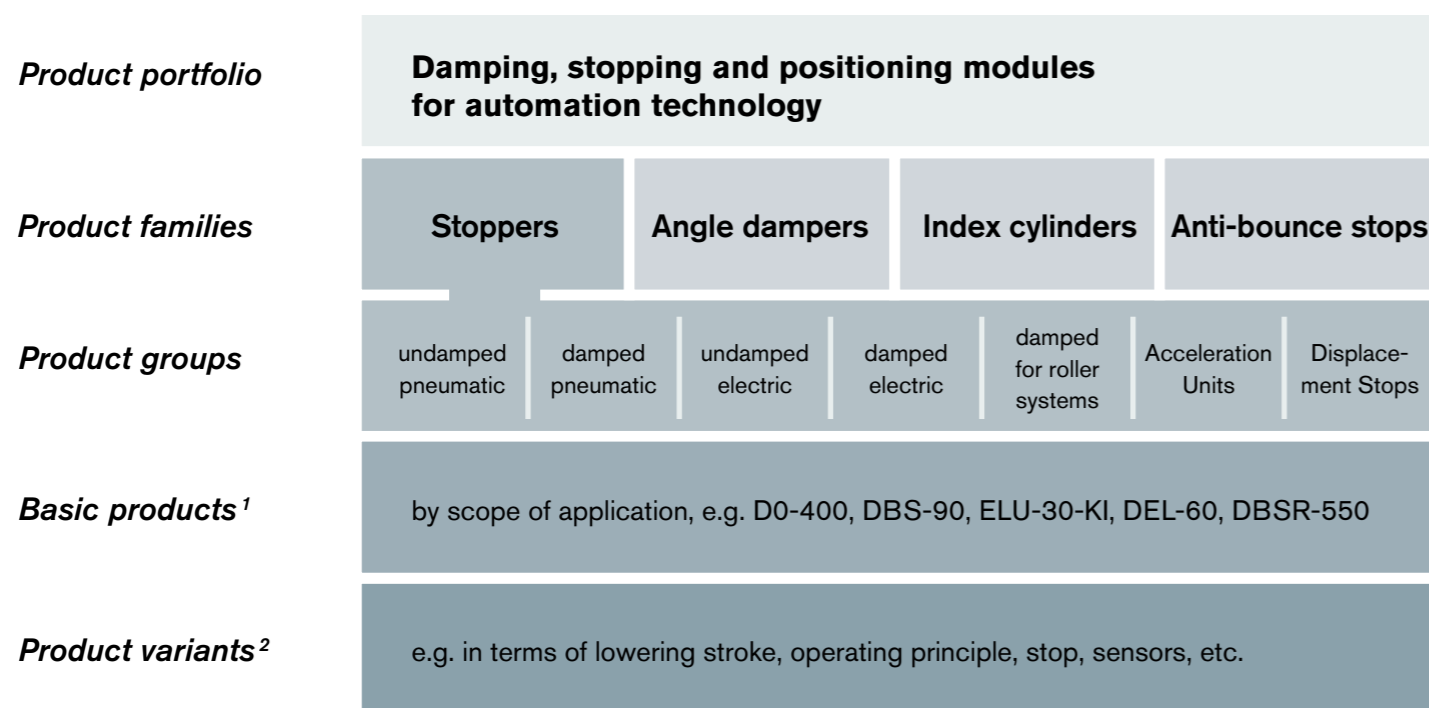

¹ The basic products differ in their scope of application, primarily in terms of the maximum pallet weight that can be stopped.
² The product variants – i.e. the products that can be ordered – are determined by selecting the required technical characteristics, for example in terms of lowering stroke, function, temperature range or stop design.

Order code

You can identify the product variant that is right for your application by consulting the relevant basic product data sheet.

You can choose between the variants defined there, for example on the basis of the lowering stroke, function, temperature range or stop design.

We would be delighted to assist you in choosing your product variant or by developing a custom product tailor-made for your application.

The example opposite illustrates the composition of the order code for a pneumatically driven, damped stopper of type DBS-90.

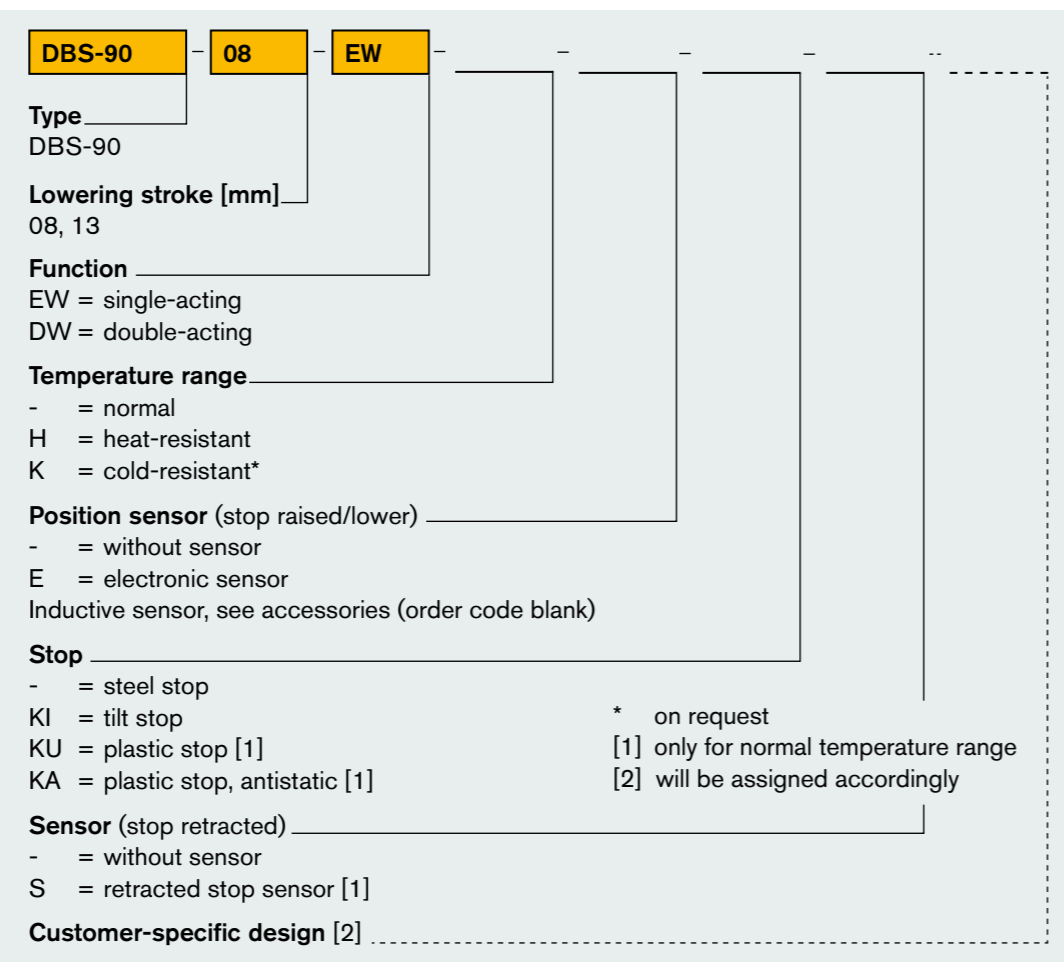

Glossary

Acceleration unit

The acceleration unit ensures that the pallet leaves the machining station more quickly so that the next machining cycle can start earlier.

Air consumption

A unit's compressed air consumption expressed in litres per work cycle, usually at a working pressure of 6 bar.

Angle damper

For stopping with change of direction. Preferred solution for changes of direction during the conveying of shock-sensitive or fragile parts.

Anti-bounce stop

For preventing rebound. Holds the pallet loaded with individual parts in position with absolute precision to prevent any rebound. Used in particular in combination with undamped stoppers.

Basic product

Standard products that are differentiated according to area of application (essentially according to the maximum pallet mass to be stopped) and serve as the basis for individual product variants.

Coefficient of friction

Designates the friction between the conveyor equipment and pallet. Important for the design of the stopping point because both the damping and the lowering capacity depend on the friction.

Conveyor speed

Speed at which the pallet is transported.

Damping stroke

Distance travelled by the stop when decelerating the pallet. The length of the damping stroke is important for the stopper's damping capacity.

Deceleration force

Required to slow the pallet down to a halt and dissipate the kinetic energy stored in the pallet. It consists of the damping force and the propelling force, which continues to have an effect even during the damping operation.

Double-acting

Both the lowering and the raising of the stop (into the locked position) are pneumatically or electrically driven movements. Advantages: closed pneumatic system, higher lowering forces as no spring force has to be overcome.

Electronic sensor

Electronic, non-contact sensor system for the detection of certain stop positions.

Friction

Force required to set a stationary body in motion or to continue to move a moving body in a constant way. Is a function of the coefficient of friction and weight of the body.

Index cylinder

For raising and positioning. Guarantees precise positioning and vertical lifting of the pallet and is ideal for rapid positioning tasks. The workpiece can be processed without vibration.

Inductive sensor

Inductive, non-contact sensor system for the detection of certain stop positions.

Lowering stroke

Distance travelled by the stop to clear and lock (lower or raise) the pallet.

Operating pressure

Working pressure of the pneumatic system. Specifications in data sheets (for the lowering force, for example) usually refer to a operating pressure of 6 bar.

Order code

The order code reflects the composition of a product variant and uniquely identifies this. It is possible to order directly from Wörner using this code.

Pallet weight

Weight of the pallet and/or the workpiece.

Position sensor

Accessory available for many stopper models. Can be used to determine the position of the stop. For full functionality, further accessories are required (proximity switch, for example).

Product variant

Variant derived from a basic product (for example in terms of lowering stroke, function, temperature range or stop design). The name of the product variant corresponds to the order code that can be used to order the unit from Wörner.

Propelling force

Friction force between the conveyor equipment and pallet. Is a function of the coefficient of friction, pallet weight and acceleration due to gravity.

Scope of application

Identifies a stopper's damping capacity. Table specifying the maximum pallet weight that can be stopped at different conveyor speeds.

Separating stop, damped

For stopping and clearing pallets. For shock-sensitive, fragile parts. Pallets are gently decelerated as they arrive so that workpieces reach their final position without rebound. The forces transferred to the conveyor system are considerably reduced.

Separating stop, undamped

For stopping and clearing pallets. Tough, economical basic design. Suitable for use wherever one or more pallets are to be accumulated at a defined position.

Single-acting

Lowering is a pneumatically or electrically driven movement. By contrast, the stop is raised into the locking position by spring force. Benefits: Easier to control because, for example, only one pneumatic connection is needed. When no compressed air is supplied, the stopper always moves to the locked position (safety feature).

Stop

Component that stops the pallet. Available in a number of designs (plastic stop, steel stop, tilt stop, various dimensions). The combination of pallet and stop materials is an important factor determining the achievable lowering force.

Wörner worldwide

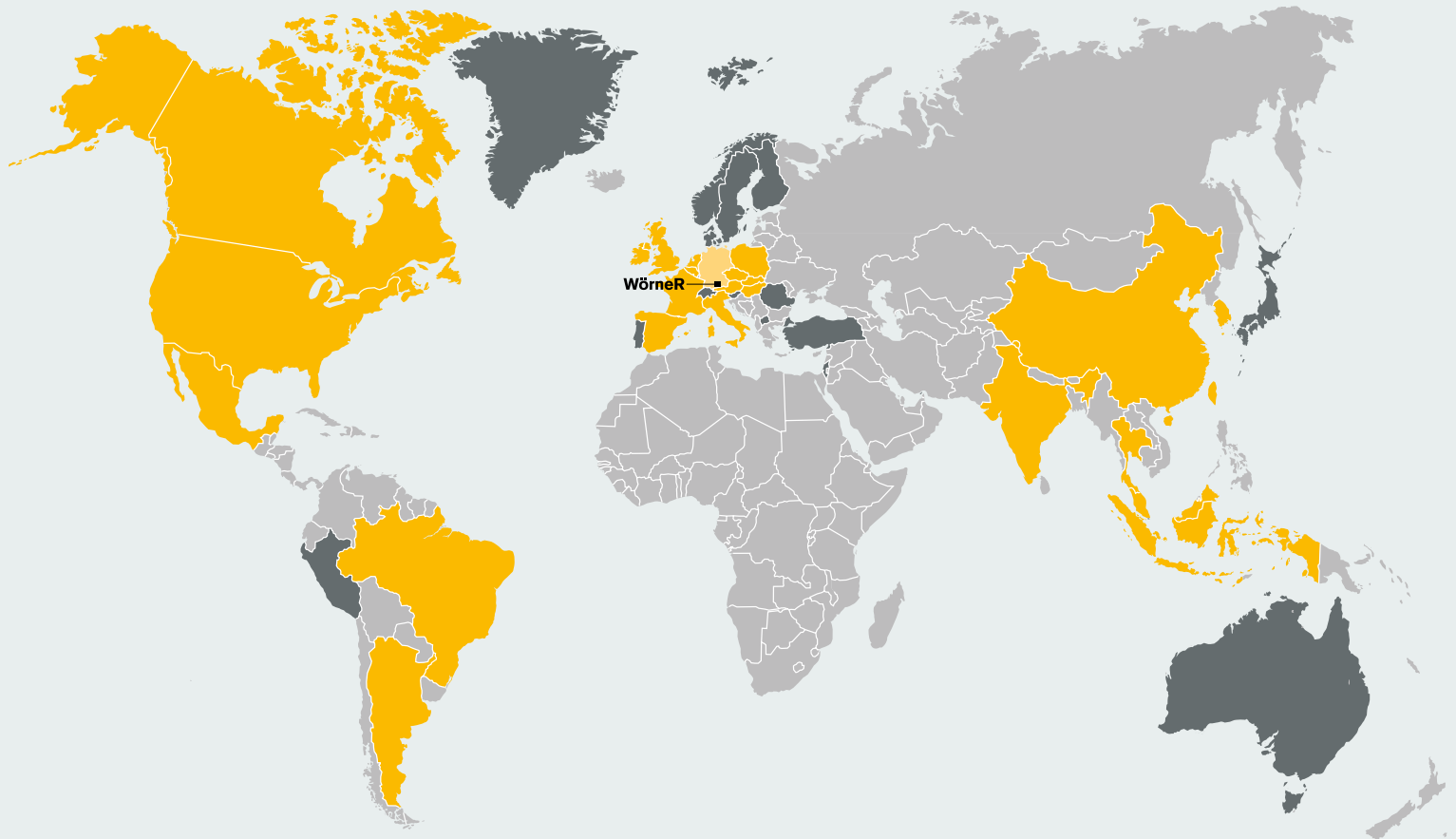

- Countries with regional sales offices or partners
- Countries with well-established customer relationships

Contact details of our international sales partners are available on our website: www.woerner-gmbh.com

Contact us for more

We are committed to exceptional service and support.

If you should have any questions related to products, orders or shipments, or if you should require personal advice, simply contact our headquarter in Denkendorf. We will put you in touch with a representative who understands your needs.

Wörner Automatisierungstechnik GmbH

Rechbergstraße 50
73770 Denkendorf
Germany

Tel. +49 711 601 609-0
Fax +49 711 601 609-10

sales@woerner-gmbh.com
www.woerner-gmbh.com